

The logo for Ragni, featuring a stylized blue 'R' inside a square frame followed by the word 'Ragni' in a blue, italicized, sans-serif font.

The logo for Somfy, with the word 'somfy' in a lowercase, orange, sans-serif font.

The logo for EXPALUM, featuring a stylized 'EX' in red and green followed by 'PALUM' in black. Below it, the text 'EXTREMEÑA DE PERFILADOS DE ALUMINIO, S.L.' is written in a smaller, red, sans-serif font.

The logo for A-OK, with 'A-OK' in yellow, bold, sans-serif font inside a black rectangular box, followed by a registered trademark symbol (®).

The logo for ALULUX, with the word 'ALULUX' in a bold, red, sans-serif font, followed by a registered trademark symbol (®).

The logo for PRO NE MA, with the words 'PRO', 'NE', and 'MA' stacked vertically in a black, sans-serif font.

WWW.SHUTTER-GATE.COM
SALES@SHUTTER-GATE.COM

The Facebook logo, a white 'f' inside a blue square.
Find us on
Facebook



ART: 227
**DETAILS TECHNOLOGY
MADE IN ITALY
EXCLUSIVE AGENCY**



ART : 3003.4



ART : 3303.25



ART : 3300



ART : 3310



ART : 0720



ART : 0140



ART : 0115



ART : 3360



ART : 105



ART : 0102

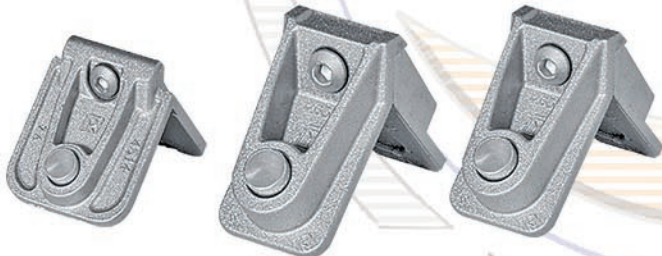

Corners

ART : 0199



ART : 0199C



ART 0188



ART : 0186

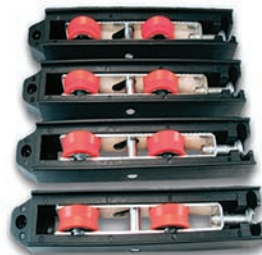

ART : 0119





ART : 0097



ART : 188AD.1

STAINLESS STEEL: 304

Art :SA 12"
SA 16"
SA 20"
SA 24"
SA 28"

STAY FRICATION ARMS

ART. CODE	Description	Max ANGLE	Max Vent size (cm)	Max Weight (KG)
SA12"	Stay Arm size 12" S.S. 304 Thikness 2,5 mm (4 Bars) Base 19 mm	30°/35°	70 X 120	35
SA16"	Stay Arm size 16" S.S. 304 Thikness 3 mm (5 Bars) Base 22mm	30°/35°	100 X 130	60
SA20"	Stay Arm size 20" S.S. 304 Thikness 3 mm (5 Bars) Base 22mm	20°/25°	140 X 140	98
SA24"	Stay Arm size 24" S.S. 304 Thikness 3 mm (5 Bars) Base 22mm	20°/25°	170 X 150	119
SA28"	Stay Arm size 28" S.S. 304 Thikness 3 mm (6 Bars) Base 22mm	20°/25°	200 X 150	132



ACCESSORIES R50

ART : 3021.4

ART : R75

ART : 2911

ART : 0017.5

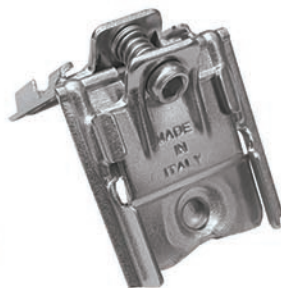



ART : 0097



ART : 188AD.1

STAINLESS STEEL: 304

Art :SA 12
SA 16"
SA 20
SA 24
SA 28

STAY FRICATION ARMS

ART. CODE	Description	Max ANGLE	Max Vent size (cm)	Max Weight (KG)
SA12"	Stay Arm size 12" S.S. 304 Thikness 2,5 mm (4 Bars) Base 19 mm	30°/35°	70 X 120	35
SA16"	Stay Arm size 16" S.S. 304 Thikness 3 mm (5 Bars) Base 22mm	30°/35°	100 X 130	60
SA20"	Stay Arm size 20" S.S. 304 Thikness 3 mm (5 Bars) Base 22mm	20°/25°	140 X 140	98
SA24"	Stay Arm size 24" S.S. 304 Thikness 3 mm (5 Bars) Base 22mm	20°/25°	170 X 150	119
SA28"	Stay Arm size 28" S.S. 304 Thikness 3 mm (6 Bars) Base 22mm	20°/25°	200 X 150	132



ACCESSORIES R50

ART : 3021.4

ART : R75

ART : 2911

ART : 0017.5

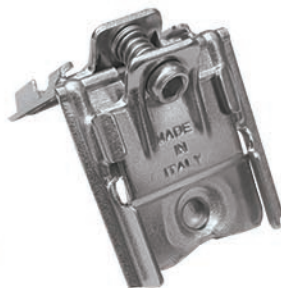

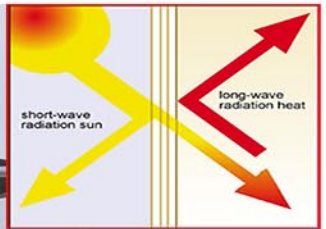

PROTECTION FROM DUST

Protection from the heat

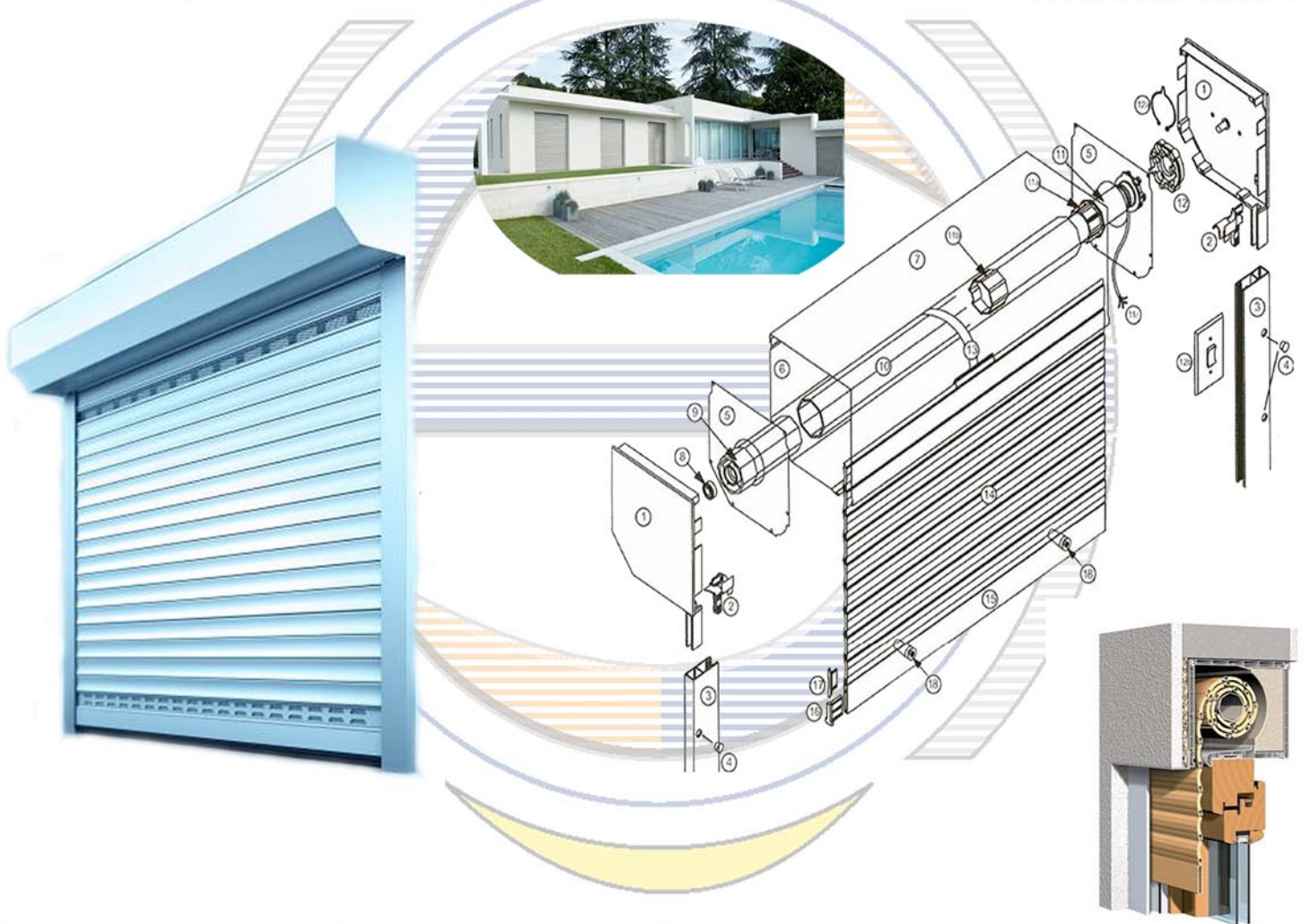

Protection from noise

Ali baba very sad

Protection from weather conditions

somfy®



MADE IN FRANCE



Altus RTS

Ø 40 & 50



Remote controls RTS centralization

Situo RTS

Telis 16 RTS



Several versions to meet your needs:

- 1 channel for a single blind
- 2 channels, ideal for double curtains (sheer and blackout)
- 5 channels for your best convenience
- Soliris Versions 1 or 5 channel, ideal to manage one or several equipment and the sun function associated with the sun sensors RTS.



- 16 channel radio remote.
- To control 1 blind or several motorized blinds by room, by façade, by storey... by creating up to 16 groups.
- Up, Down and Stop functions.
- Favorite position "my".

CENTRALIS indoor RTS

Smoove Origin RTS



- The Centralis indoor receiver RTS is a radio receiver for an AC switching motor.
- RTS Radio technology.
- Mount style: flush; for surface mount, use with surface mount box.
- Compatible with: Inis RT, Centralis RTS, Telis 1 RTS, Telis 4 RTS and Chronis RTS.



Wall-mounted, mechanical, single-channel control unit.

- Up, down & stop functions.
- «my» favorite position.
- Module available in white finish.
- Frames available in 8 finishes.

CONNEXOON

VISIDOM ICM 100



- Image resolution: HD 1280 x 720
- Image sensor: 1/4" CMOS
- Image compression: H.264
- Viewing angle H : 75° V : 45°
- Angle motorisation H : 270° V : 0°
- Night vision: 5 IR LEDs (5 m)
- Audio: Integrated microphone and loudspeaker
- Video recording: 1 min / record

Moco Controller

RS485 Transmitter



- Used to control 4 motors master & individual wired & wireless in the same time



Motor controller for RTS motors and receivers. It converts RS485 Somfy commands, coming from home control systems, into RTS orders.

Functions with motors/receivers: open, close, stop, go/record/delete a favourite position, activate/deactivate the sun protection, open the programming mode, tilt up and down.

Functions with RTS lighting receivers: ON< OFF, go/record/delete a favourite light level, open the programming mode, dim up and down.

WWW.SHUTTER-GATE.COM
SALES@SHUTTER-GATE.COM

Find us on Facebook



Dexxo RTS



Elixo 800
Elixo 2000



Ixengo 400



Levixo 230V
/-24V RTS

UP TO 15 M²

Reliable and robust motorization for every installation configuration

- **Very easy to use**
 - Starts working in less than 90 s.
 - All settings are pre-programmed.
- **Extensive scope for customizing the installation**
 - Adjustable obstacle detection sensitivity.
 - Adjustable docking speed when closing.
 - Built-in lighting.
 - Part opening possible.
 - A wide range of safety & convenience accessories can be connected.
 - A backup battery can be incorporated in motor unit to cater for power cuts.
- **Garage door security features**
 - Burglar-proof lock.
 - Alarm siren triggered in event of forcing.
- **Compatible with solar power supply**

UP TO 10 M | 2000 KG

Reliable and hard-wearing for sliding gates

- **Easy to install**
 - Easy access to ground fixation screws from the top.
 - No adjustment needed from the installer.
- **Reliability and durability**
 - Mechanical design based on 30 years of experience.
 - Soft stop
- **Convenient to use**
 - Easy key unlocking from inside.

UP TO 4 M | 400 KG PER LEAF

Powerful, efficient and safe for the largest iron-and-steel gates

- **3S Control Box:** quickly installed, customizable, intuitive
- **A powerful motor**
 - Suitable for leaves up to 4 m - 400 kg
 - Durability withstanding use for up to 60 openings and closings per day
 - Soft stop
- **Meeting your need for efficiency**
 - Installation requiring no special tools and no welding
 - Adjustable fixing brackets, adapting to all installation configurations
 - Motorizable single-leaf gates with a single-motor reference
- **Safe to use**
 - Its non-reversing mechanism provides excellent resistance against high winds or forcing
 - A special key allows easy unlocking from inside

UP TO 6 M

Road barriers robust, durable and suitable for intensive use.

- **Self-learning**
- **Hand operation from outdoor with key**
- **Suitable for intensive use up to 1200 cycles/day**
- **General overall size:**

Standard installation

1. Elixo 800/2000 RTS
2. Orange light
3. Outdoor antenna

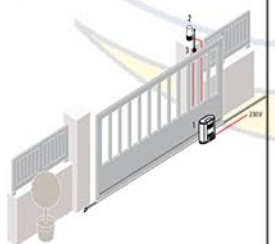

Standard installation

1. Somfy Ixengo 400 RTS
2. Orange light
3. Outdoor antenna
4. Video door phone
5. Control box

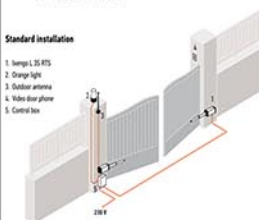

* Application area

Overall	In detail
Weight: 400 kg	4 m and 150 kg
	3 m and 200 kg
	2 m and 400 kg

Electric lock recommended for leaves above 2 m

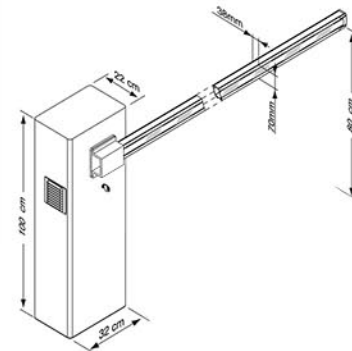

AM45 Ø45 AM45 Multiple Electronic Limit Super Silent Tubular Motor



Features

- AC power supply
 - Electronic limit
 - Built-in radio receiver
 - Multiple limits setting
 - Quiet design
 - Smart controls
 - Tilting to adjust light
- Exclusive silent technology, super silent run, sound value below 35dB
 - Over torque output protection
 - Double sides patent brake structure
 - Superheterodyne receive module with high sensitivity -110dBm
 - Set limit positions on remote, suitable for height applications
 - Stop on block to protect object and user from damage
 - Double hall sensors check motor turn to ensure the high precise limits
 - Multiple limits to meet with various applications
 - Built in control board covered by sealed plastic box to reduce electromagnetic interference

AM45 Ø45 Short tubular motor



Features

- AC power supply
 - Mechanical limit
- Silent run, sound value below 45dB.
 - Precise limit switch, repeated limit accuracy $\pm 2^\circ$
 - Suitable to the narrow width roller shutter.

AM45 Ø45 Built-in radio tubular motor



Features

- AC power supply
 - Mechanical limit
 - Built-in radio receiver
 - Smart controls
 - Tilting to adjust light
- Quiet design, sound value below 45dB
 - Precise limit switch, repeated limit accuracy $\pm 2^\circ$
 - Maximum limit circle 55
 - Double sizes patent brake structure
 - Built-in radio receiver, easier installation
 - Surge current resistance relay, industry level CPU, working temperature -40 ~ +85
 - Precise SMT production, damp proof deal with on surface
 - Superheterodyne receiving module achieve sensitivity -110dBm

AM45 Ø45 Standard tubular motor



Features

- AC power supply
 - Mechanical limit
 - Quiet design
 - Smart controls
- Quiet design, sound value below 45dB
 - Double sides patent brake structure
 - Precise limit switch, repeated precise accuracy reach $\pm 2^\circ$
 - Maximum limit circle 55





CHINA



GERMANY

AC140
1 - 2 - 6 - 16 CHANNEL

AC123 HAND - HELD EMITTERS 1-2-6-16 CHANNEL



- > Simple trend design
- > Luxurious Piano Lacquer surface treatment, honorable and elegant
- > Acrylic face panel with high hardness, no scratch and flawless looking
- > White and black color, suit to various decorations
- > CR2032 button battery, easy to get and replace

AC127 HAND - HELD EMITTERS 1-2-6-16 CHANNEL



- > Simple trend design
- > Luxurious Piano Lacquer surface treatment, honorable and elegant
- > Acrylic face panel with high hardness, no scratch and flawless looking
- > Magnet mounting holder, easy to install
- > White and black color, suit to various decorations
- > No screws on the products, easy to replace battery
- > Lower power loss design, battery last 2-3 years

AC127L RECHARGEABLE HAND - HELD EMITTERS 1-2-6-16 CHANNEL AC128-01 EMITTER WITH TIMER



- > Built-in lithium battery, USB charging
- > Simple trend design
- > Luxurious Piano Lacquer surface treatment, honorable and elegant
- > Acrylic face panel with high hardness, no scratch and flawless looking
- > Magnet mounting holder, easy to install
- > White and black color, suit to various decorations
- > No screws on the products, easy to replace battery
- > Lower power loss design, battery last 2-3 years



- > LCD screen with back light, nice looking at night.
- > Touch screen, fashion and simple press.
- > Timing function, maximum 6 times to be set, daily cycle and weekly cycle.
- > Capacitor touch technology, high stability and sensitivity.
- > 16 Channels, individual and group operation.
- > Low-power design, battery lasts 2-3 years.
- > Stick on the wall with magnet wall holder.

AC133 WALL TYPE EMITTER



- > Elegant and fashion appearance
- > Frame surface treatment with piano lacquer craft
- > Acrylic material face cover free of scratch
- > Option of handheld control and Wall mounting control
- > Available for various customized color

AC128 TOUCH SCREEN EMITTER



- > Touch screen, simple and free to press
- > Capacitor touch technology, high stability and sensitivity
- > Low power design, battery last 2-3 years
- > Stick on the wall with magnet wall holder

AC229 WALL TYPE RADIO RECEIVER WITH TOUCH SCREEN



- > Work with AC tubular motor.
- > Suitable for open or concealed wall mounting.
- > Tempered glass touch face panel, scratch protection.
- > Capacitor touch technology, more sensitive.
- > Shock proof relay.
- > SMT assembly, damp-proof on surface.

AC226-01 WATERPROOF TYPE RADIO RECEIVER



- > Mini size, can be easily hidden.
- > Fully sealed design, waterproof IP65 level.
- > Freely change dot move or continuous move.
- > Shock proof relay, work with motor power under 500w.
- > Reliable and high interference resistance.
- > SMT assembly, damp-proof on surface.
- > Plastic sealed transformer, more stable.





Item	Product description/Types	Item	Product description/Types
CD142	<p>Nominal thickness: 8.5mm Surface area: 42.0mm Basic weight: 4.0kg/m² Maximum width of use: 3.0m Maximum Height of use: 4.0m Maximum area: 7.0m² Slats for 1 m height: 23.8slats</p>	CD942	<p>Nominal thickness: 9.0mm Surface area: 42.0mm Basic weight: 4.0kg/m² Maximum width of use: 3.5m Maximum Height of use: 4.0m Maximum area: 8.5m² Slats for 1 m height: 23.8slats</p> <p>Alulux development :</p> <ul style="list-style-type: none"> 1- 20% Harder foam. 2- 11% High value for impact test. 3- 15% Increased torsion resistance.

Item	Product description/Types	Item	Product description/Types
CD300	<p>Nominal thickness: 14.0mm Surface area: 55.0mm Basic weight: 4.5kg/m² Maximum width of use: 3.5m Maximum Height of use: 4.0m Maximum area: 10.0m² Slats for 1 m height: 18slats</p>	CD200	<p>Nominal thickness: 14.0mm Surface area: 55.0mm Basic weight: 5.5kg/m² Maximum width of use: 4.5m Maximum Height of use: 4.0m Maximum area: 12.0m² Slats for 1 m height: 18slats</p>



MADE IN SPAIN
SHUTTER INSULATED SLATS

45-0 mm



Ejes – Axis – Axes	Heigh of roller shutters in boxes Enroulements en cm Enrollamientos en cm		
	40	60	ZF54
ALU. 137 45° - 90°	112	130	110
ALU. 150 45° - 90°	148	166	135
ALU. 165 45° - 90°	216	211	180
ALU. 180 45° - 90°	274	261	265
ALU. 205 45° - 90°	373	360	325
ALU. 250 45° - 90°	480		

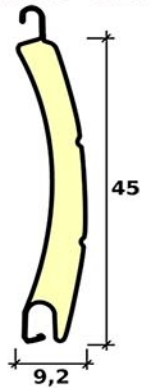

55E mm



Ejes – Axis – Axes	Enrollamientos en cm. Heigh of roller shutters in boxes Enroulements en cm.		
	60	70	ZF54
ALU. 250 90°	357	357	280
ALU. 250 45°	357	357	253
ALU. 300 45°	533	533	407
ALU. 350 45°	550	495	588
ALU. 400 45°	800	720	830

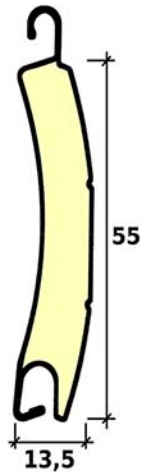

77C mm



Ejes – Axis – Axes	Enrollamientos en cm. Heigh of roller shutters in boxes Enroulements en cm.		
	70	100	130
ALU. 90° 250	223	251	238
ALU. 45° 250	223	251	238
ALU. 45° 300	350	320	280
ALU. 45° 350		519	498
ALU. 45° 400		741	636
ALU. 1/4 REDONDO 250	223	251	238
ALU. 1/4 REDONDO 300	350	320	280

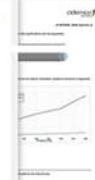
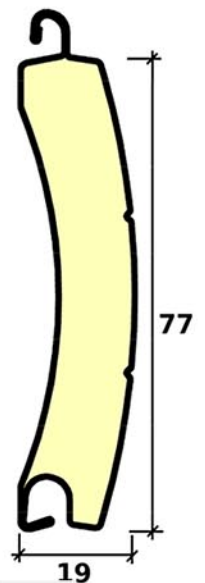



Extruded Slat 40 / 55



Guide Channel 6.3 cm

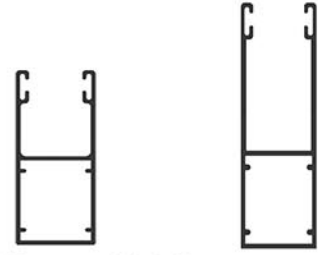

Guide Channel 5.3 cm

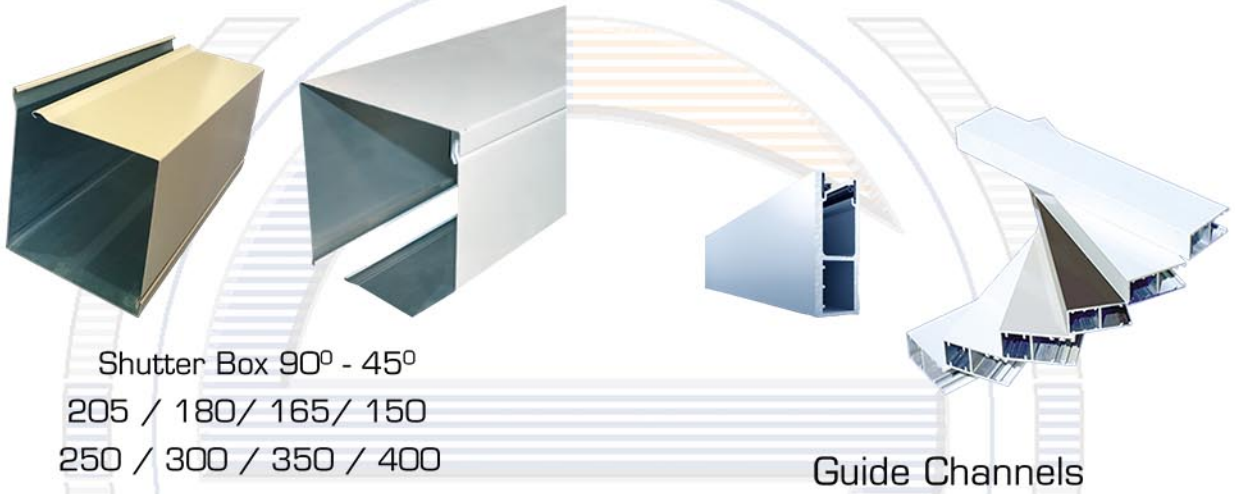

Shutter Box 90° - 45°
205 / 180 / 165 / 150
250 / 300 / 350 / 400

Guide Channels



End Cap 90° - 45°
165 / 150
180 / 205 / 250

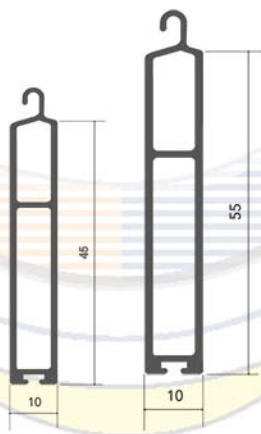

End slat



Octagonal tube 40 / 60 / 70



Side Locks



Entry Guide

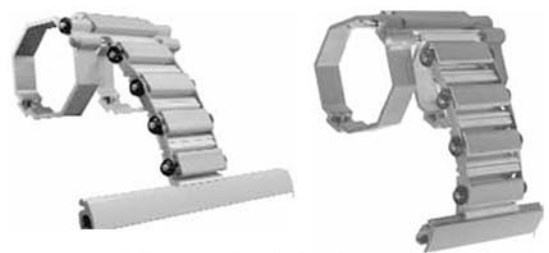

Security Spring

Gaviota Simbac

SMART AWNINGS AND ROLLING SHUTTERS

MADE IN SPAIN



MADE IN ITALY



Assist Springs



Manual Gear 1:18



Manual Gear 1:11



Shutter Belt

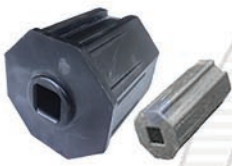
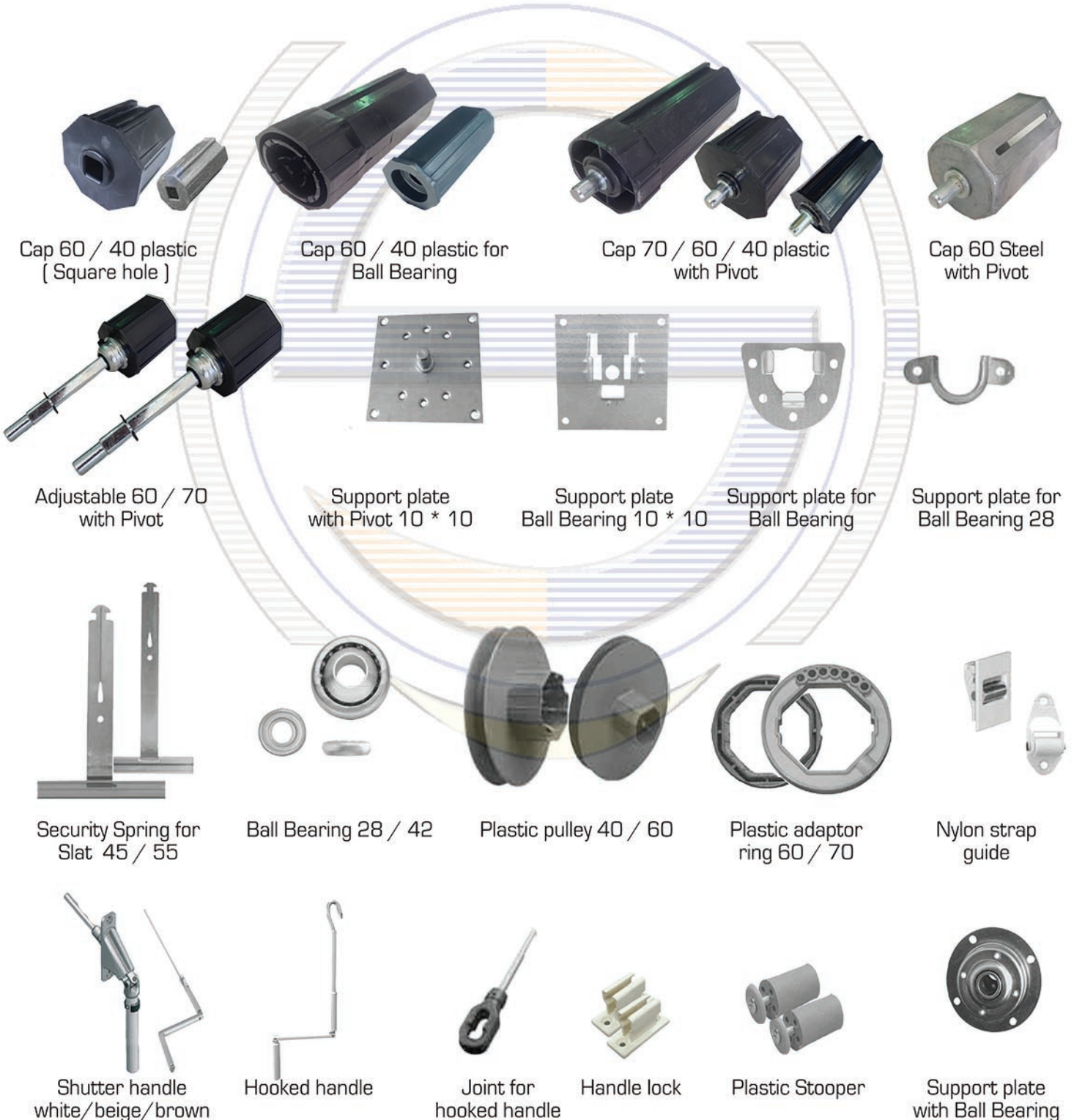

Cap 60 / 40 plastic
(Square hole)



Cap 60 / 40 plastic for
Ball Bearing



Cap 70 / 60 / 40 plastic
with Pivot



Cap 60 Steel
with Pivot



Adjustable 60 / 70
with Pivot



Support plate
with Pivot 10 * 10

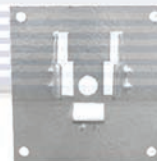

Support plate
Ball Bearing 10 * 10



Support plate for
Ball Bearing



Support plate for
Ball Bearing 28



Security Spring for
Slat 45 / 55



Ball Bearing 28 / 42



Plastic pulley 40 / 60



Plastic adaptor
ring 60 / 70



Nylon strap
guide



Shutter handle
white/beige/brown



Hooked handle



Joint for
hooked handle



Handle lock



Plastic Stoooper



Support plate
with Ball Bearing

Double Glazing Supplies



RDCC229S/CL

Crystal Tuscan 229



RDCC308S/DCH

Crystal Milano 308



RDCC232G/DGC

Crystal Verona 232

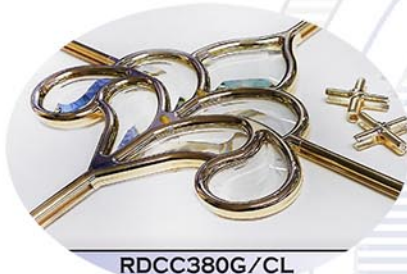

RDCC380G/CL

Crystal Brescia 380



RDCC315B/CL

Crystal Florence 315



RDCC247W/ST

Crystal Cataia 247



Tuscan 229



Milano 308



Corsica 314



Napoli 336

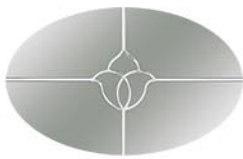

Palermo 369



Arabic Star
Open 9024



Verona 232



Modena 328



Ferro Battuto
9016



Arabic Star
Square 9021



Arabic Star
Open 9023

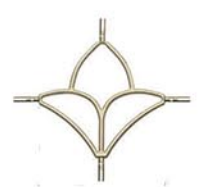

Florence 9019
Gold / Chrome



FBSprofilati s.r.l.

**DECORATIONS
FOR DOUBLE
GLASS**

MADE IN ITALY



MADE IN ITALY

FBS 9014



FBS 9015

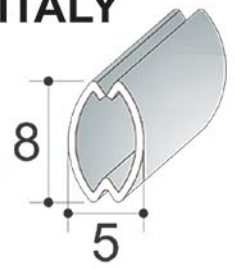

FBS 9338 - ALU

FBS 9339 - ALU

FBS 9013

FBS 9324 - ALU

FBS 9012

FBS 1322

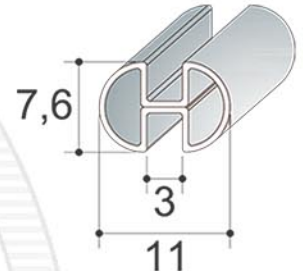
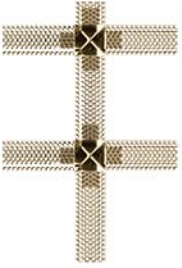

FBS 9034

FBS 9035

FBS 9037

FBS 1133



WWW.SHUTTER-GATE.COM
SALES@SHUTTER-GATE.COM

Find us on
Facebook

46 Double-sideways spring operated insect screen

Cod. 9003412



- Features**
- 46mm double roller screen case
 - Pressure-fitting endcaps in nylon
 - 25mm Ø reinforced internal winding roll
 - 40x22mm guide with double brush
 - 22x22mm reinforced lower guide with double brush
 - Counter profile with magnet
 - 39x8,5mm sliding bar
 - Inner and outer handle
 - Door latch H 1000mm
 - Door latch on semi-fixed door
 - Scroll bearings included
 - Anthracite-colored fiberglass mesh
 - Standard window reveal fitting (6 clips)

46 Vertical spring operated insect screen

Cod. 9003112



- Features**
- 46mm roller screen case
 - Pressure-fitting endcaps in nylon
 - 25mm Ø reinforced internal winding roll
 - 40x22mm guide with double brush
 - Adjustable external catches
 - 39x8,5mm sliding bar
 - Anthracite-colored fiberglass mesh
 - Standard window reveal fitting option without clips

Available colors

- 9016 Matt White
- 098 Matt Black P9004
- 1013

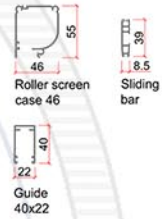

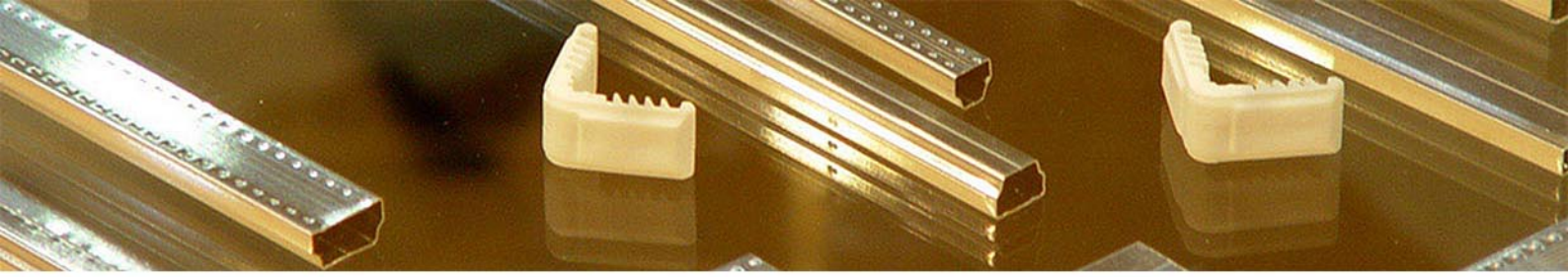

Aluminium Spacer



MADE IN ITALY

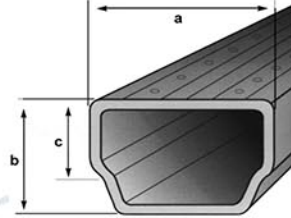
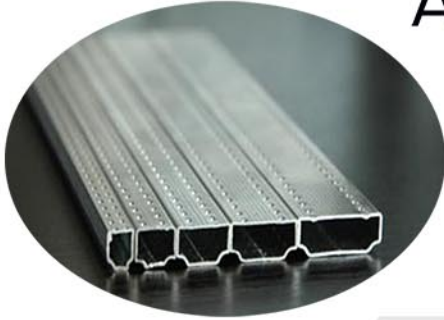

DIMENSIONS IN mm			MTRS/PAC KET
a	b	c	
5,5	6,5	5	2.500
7,5	6,5	5	2.000
8,5	6,5	5	1.650
9,5	6,5	5	1.575
11,5	6,5	5	1.250
13,5	6,5	5	1.210
14,5	6,5	5	1.100
15,5	6,5	5	1.035
17,5	6,5	5	920
19,5	6,5	5	805

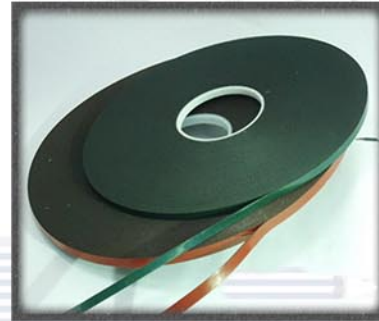

Double glazing tape



Desiccant
For alu-spacer



THE MAIN FUNCTIONS

A solar solution reliable and simple to install



Protected against freezing

The motor stops in the event of freezing (and also if the final slat is locked)



«My» favorite

To move in one click your shutter to your pre-recorded favourite position



Tamper resistant

Burglary delayed



Compatibility with all types of Roller shutters

(CWS, RRS, roof and facades windows)



Somfy Drive Control

Burglary delayed



Obstacle detection

Stops if it meets an obstacle when coming down



Autonomy

Energy saving and guaranteed in all conditions

Oximo WireFree RTS is an autonomous motorized system

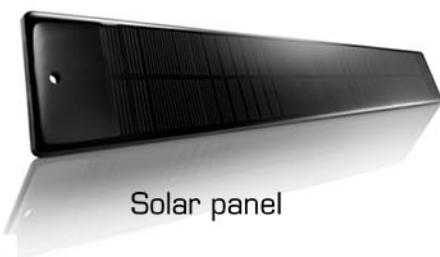

Solar panel



Battery with aluminium casing





Opener For Windows & Sky Light



Horizontal Curtain



Fly Screen



Vertical Curtain

We Always Import The Latest Technology

WWW.SHUTTER-GATE.COM
SALES@SHUTTER-GATE.COM

 Find us on
Facebook



SHUTTER GATE TRADING

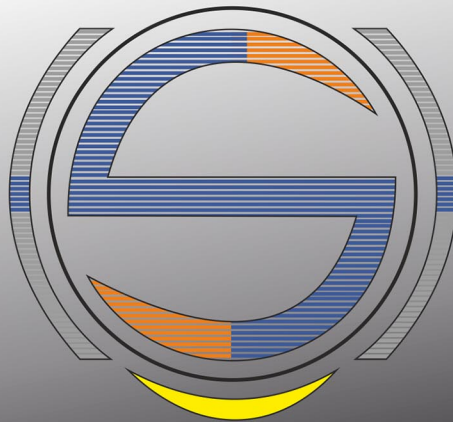

ROLLING SHUTTER - AUTOMATIC DOOR
ALUMINUM & GLASS ACCESSORIES
BLINDS - CURTAINS & AWNING